

MB7052
MB7092



XL- MaxSonar® - WRM1™ MB7052

XL- MaxSonar® - WRMA1™ MB7092

Weather Resistant (IP67) Sonar Range Finder with High Power Output, Noise Rejection, Most Likely Target Filtering, Auto Calibration & Long-Range Narrow Detection Zone

The MB7052 and the MB7092 provide users with robust range information in air. The sensor ignores smaller targets and only reports the range to the target with the largest acoustic return. Additional filtering in the MB7052 and MB7092 also rejects moving target clutter such as rain or snow, electrical noise, and outside acoustic noise. This sensor also features high-power acoustic output along with real-time auto calibration for changing conditions (supply voltage sag, acoustic noise, or electrical noise), operates with supply voltage from 3V to 5.5V, detects objects from 0-cm to 765-cm (25.1 feet) and provides sonar range information from 20-cm out to 765-cm with 1-cm resolution. Objects from 0-cm to 20-cm range as 20-cm or closer. The sensor is housed in a compact, robust PVC housing, designed to meet IP67 water intrusion, and matches standard electrical/water 3/4" PCV pipe fittings. The user interface formats included are pulse-width (MB7052), real-time analog-voltage envelope (MB7092), analog voltage output, and serial output.

Features

- Clutter rejection provides range to the largest amplitude reflection (target) within the field of view
- Real-time auto calibration and noise rejection and additional filtering provides user with robust stable range information
- High acoustic power output
- Precise narrow beam
- Object detection includes zero range objects
- 3V to 5.5V supply with very low average current draw
- Free run operation can continually measure and output range information
- Triggered operation provides the range reading as desired
- All user interfaces are active simultaneously
- Serial, 0 to Vcc, 9600Baud, 81N
- Analog, (Vcc/1024) / cm
- Real-time analog envelope (MB7092), or Pulse-width output (MB7052)
- Ranging can occur every 100mS (10Hz) for MB7092 and 150mS (7.5Hz) for the MB7052

Benefits

- Excellent for ranging large objects in the presence of cluttered or noisy environments
- Excellent for applications that require consistently accurate outputs, even if used where outside influences would affect other acoustic sensors
- Impressive acoustic and electrical noise resistance
- Reliable and stable range data
- Sensor dead zone gone
- Low cost IP67 sensor
- Quality narrow beam characteristics
- Very low power excellent for multiple sensor or battery based systems
- Ranging can be triggered externally or internally
- Sensor reports the range reading directly, frees up user processor
- Easy hole mounting or mating with standard electrical fittings
- Filtering allows very reliable operation in most environments

Applications and Uses

- Tank level measurement
 - Bin level measurement
 - Proximity zone detection
 - Environments with acoustic and electrical noise
 - Distance measuring
 - Long range object detection
 - Industrial sensor
 - -40°C to +65°C (limited operation to +85°C)
 - Physical drop-in upgrade for XL-MaxSonar-WR product, part numbers: MB7060, MB7062, MB7070, & MB7072.
-
- When the distance to the target changes, at least three range readings are required, for the sensor output to reflect this distance change.

MaxBotix® Inc.

MaxBotix, MaxSonar, & WRMA1 are trademarks of MaxBotix Inc.
XL-WR1™ & XL-WRMA1™ • v1.9b • Patent 7,679,996 • Copyright 2005 - 2012

Page 1
Email: info@maxbotix.com
Web: www.maxbotix.com
PD10028d

MB7052 & MB7092 Pin Out

- Pin 1** - Leave open (or high) for serial output on the Pin 5 output. When Pin 1 is held low the Pin 5 output sends a pulse (instead of serial data), suitable for low noise chaining.
- Pin 2** - MB7052 This pin outputs a pulse-width representation of range. To calculate the distance, use a scale factor of 58uS per cm.
MB7092 This pin outputs the analog voltage envelope of the acoustic waveform. For the MB7092, this is a real-time always-active output.
- Pin 3** - (AN) This pin outputs analog voltage with a scaling factor of (Vcc/1024) per cm. A supply of 5V yields ~4.9mV/cm., and 3.3V yields ~3.2mV/cm. Hardware limits the maximum reported range on this output to ~700 cm at 5V and ~600 cm at 3.3V. The output is buffered and corresponds to the most recent range data.
- Pin 4** - (RX) This pin is internally pulled high. If Pin-4 is left unconnected or held high, the sensor will continually measure the range. If Pin-4 is held low the sensor will stop ranging. Bring high 20uS or more to command a range reading.
- Pin 5** - (TX) When Pin 1 is open or held high, the Pin 5 output delivers asynchronous serial with an RS232 format, except voltages are 0-Vcc. The output is an ASCII capital "R", followed by three ASCII character digits representing the range in centimeters up to a maximum of 765, followed by a carriage return (ASCII 13). The baud rate is 9600, 8 bits, no parity, with one stop bit. Although the voltages of 0V to Vcc are outside the RS232 standard, most RS232 devices have sufficient margin to read the 0V to Vcc serial data. If standard voltage level RS232 is desired, invert, and connect an RS232 converter such as a MAX232. When Pin 1 is held low, the Pin 5 output sends a single pulse, suitable for low noise chaining (no serial data).
- V+** Operates on 3V - 5.5V. The average (and peak) current draw for 3.3V operation is 2.1mA (50mA peak) and 5V operation is 3.4mA (100mA peak) respectively. Peak current is used during sonar pulse transmit.
- GND** Return for the DC power supply. GND (& V+) must be ripple and noise free for best operation.

MB7052 & MB7092 Circuit

The sensor functions using active components consisting of an LM324 and PIC16F690, together with a variety of other components. The schematic is shown to provide the user with detailed connection information.

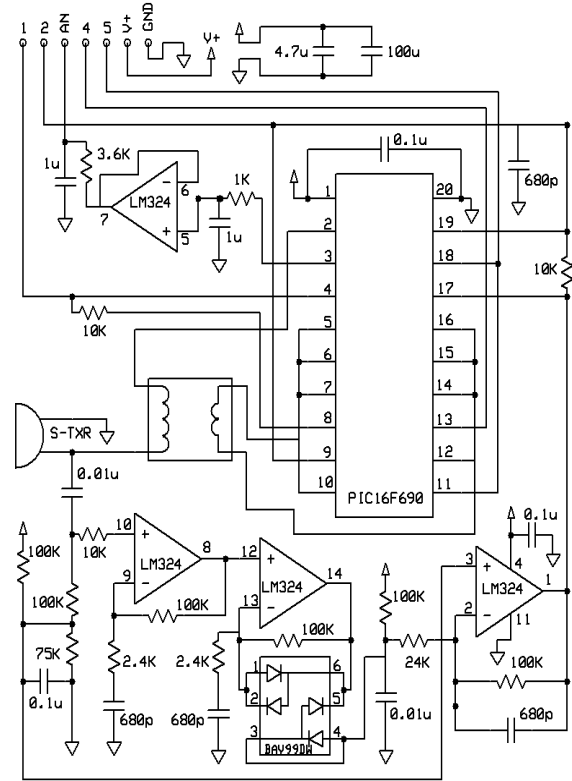

MB7052 & MB7092 Real-time Operation & Timing

175mS after power-up, the XL-MaxSonar® is ready to begin range cycles. During power up, the XL-MaxSonar® sensors require at least three range cycles in a row for the first *valid range output. If Pin-4 is left open (i.e. unconnected) or held high (20uS or greater), the sensor will take a range reading. Each range cycle starts by Pin-4 being high or open, after which the sensor calibrates for 20.5mS, and after which, thirteen 42KHz waves are sent. The sensor then determines the range to the target. Next the analog range voltage is set. At 94.3mS, for the next 4.7mS the serial data is sent.

- For the MB7092, this completes the range cycle of 99mS.
- For the MB7052, if the the distance to the target is not *valid, no pulse width data is sent, and this completes the range cycle of 99.5mS.
- For the MB7052, when the distance to the target is *valid, the pulse width is sent (active high) with a scale factor of 58uS per cm, and the range cycle completes at 149mS.

***MB7052 & MB7092 Fail Safe**

The XL sensors will report the latest valid range reading. Valid range readings are range readings that are correlated and sufficiently noise free. Valid range readings, once obtained, are held (and resent) a new valid reading set is obtained or until Fail Safe times out. After one hour (1.5 hour for the MB7052) of continuous ranging with no targets detected as valid, the sensor will report "R000" as the serial range output, set the analog-voltage range output to zero volts, (and stop sending the pulse-width output for the MB7052). The zero value is the output for a fail-safe value.

MB7052 & MB7092 Real-time Auto Calibration

Each time before the XL-MaxSonar® takes a range reading it calibrates itself. The sensor then uses this data to range objects. If the temperature, humidity, or applied voltage changes during sensor operation, the sensor will continue to function normally. (The sensor does not apply compensation for the speed of sound change verses temperature to any range readings.)

MB7052 and MB7092 Real-time Noise Rejection

The XL sensors start with the same filtering that our standard XL products have, but also use past history to filter the range readings (this is different from the standard XL product line where each reading is independently taken).

While the XL-MaxSonar® is designed to operate in the presence of noise, best operation is obtained when noise strength is low and desired signal strength is high. Hence, the user is encouraged to mount the sensor in such a way that minimizes outside acoustic noise pickup. In addition, keep the DC power to the sensor free of noise. This will let the sensor deal with noise issues outside of the users direct control (Even so, in general, the sensor will still function well even if these things are ignored). Users are encouraged to test the sensor in their application to verify usability.

For every ranging cycle, individual filtering for that specific cycle is applied. Noise from regularly occurring periodic noise sources such as motors, fans, vibration, etc., will not falsely be detected as an object. This holds true even if the periodic noise increases or decreases (such as might occur in engine throttling or an increase/decrease of wind movement over the sensor). In addition, *(because of dynamic range and signal to noise physics,) as the noise level increases, at first only small targets might be missed, but if noise increases to very high levels, it is likely that even large targets will be missed.

*In high noise environments, if needed, use 5V power to keep acoustic signal power high.

MB7052 & MB7092 Noise and Clutter Filtering

The XL-MaxSonar® are equipped with filtering firmware, which allows the sensor to ignore smaller targets and noise, yet still report the target that gives the largest acoustic return. (The sensor will also reject noise, even noise that has a higher amplitude than the acoustic return from the target.) This gives users the flexibility to consistently range larger targets, in the presence of clutter and noise. If the largest target is removed from the field of view, the XL-MaxSonar® will switch to the target that gives the next largest return. Once all targets (even small targets) are removed from the field of view, the sensor will then report its maximum distance. In addition, the reading to reading filter in the XL-MaxSonar® verifies range reading to range reading continuity.

In general, this means that the XL-MaxSonar® will select the largest target from its field of view and report its range. Even so, objects up close may provide significantly greater returns than distant objects. Users are encouraged to test the sensor in their application to verify usability.

MB7052 and MB7092 Target Speed

The MB7092 is intended for applications where the distance from the sensor to the target is moving slowly or stationary. Detection and ranging might be inhibited if the actual distance to target changes (reading to reading) by more than 10cm.

MB7052 & MB7092 Beam Characteristics

Sample results for measured beam patterns are shown below on a 30-cm grid. For situations where more than one object is present in the field of view, priority is given to the object with the largest signal return.

The detection pattern is shown for;

- (A) 0.25-inch diameter dowel,
- (B) 1-inch diameter dowel,
- (C) 3.25-inch diameter dowel.

Because of the signal processing on the MB7052 & MB7092 these sensors will generally detect clutter free objects to distances farther than shown on the graph. Also the high sensitivity of MB7052 & MB7092 allows these sensors to be used for people detection.

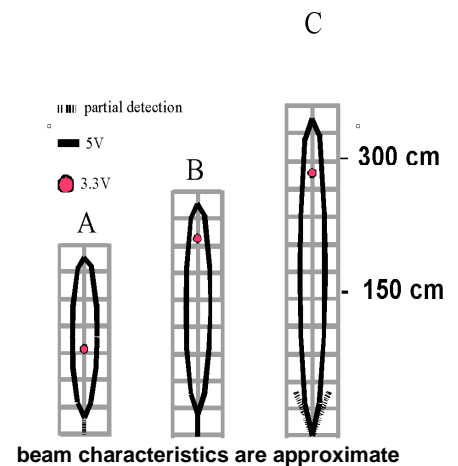

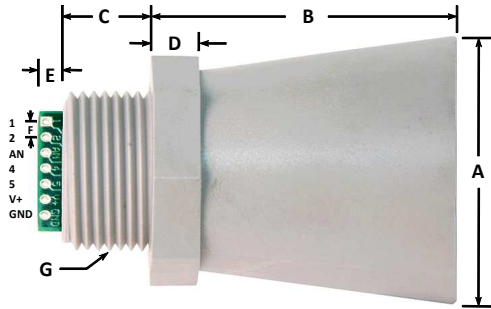

A	1.72" dia.	43.8 mm dia.
B	2.00"	50.7 mm
C	0.58"	14.4 mm
D	0.31"	7.9 mm
E	0.23"	5.8 mm
F	0.1"	2.54 mm
G	3/4" National Pipe Thread Straight	
H	1.032" dia.	26.2 mm dia.
I	1.37"	34.8 mm
weight, 1.76 oz., 50 grams		
values are nominal		

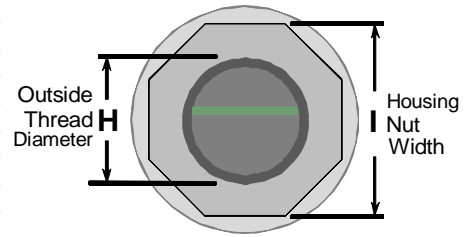

Typical Performance to Targets

Analog Envelope Output (Dowels, 5V)

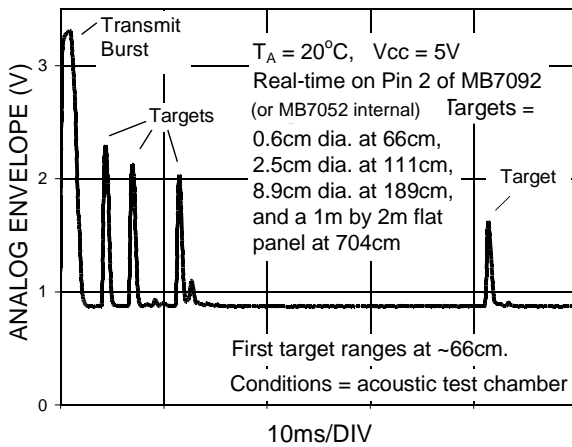

Analog Envelope Output (Dowels, 3.3V)

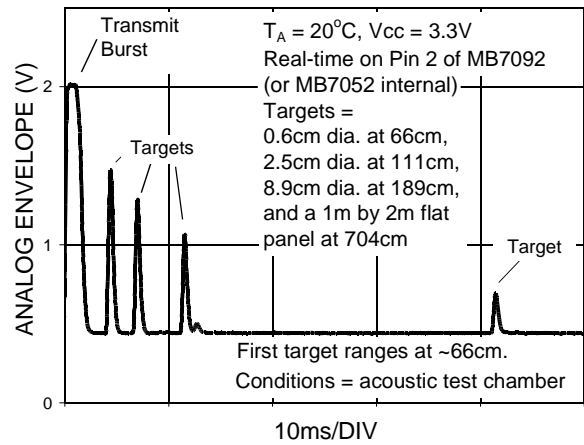

Typical Performance in Clutter

Analog Envelope Output (Clutter, 5V)

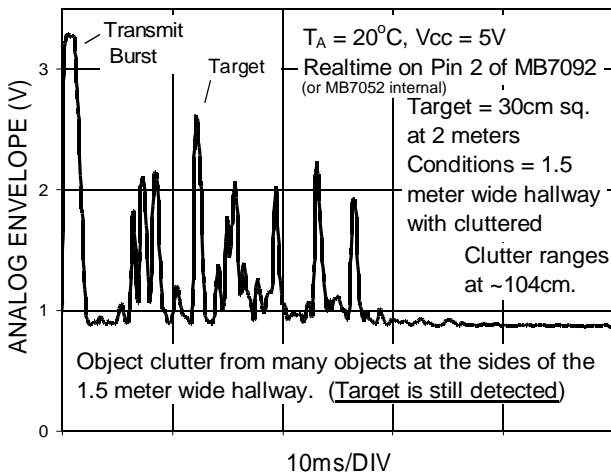

Analog Envelope Output (Clutter, 3.3V)

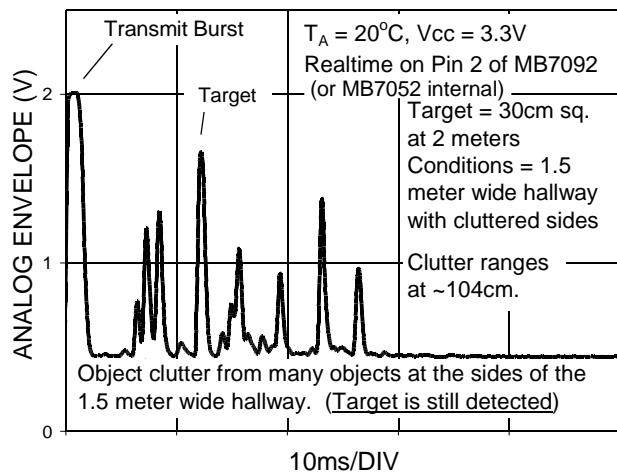

Product / specifications subject to change without notice. For more info visit www.maxbotix.com